

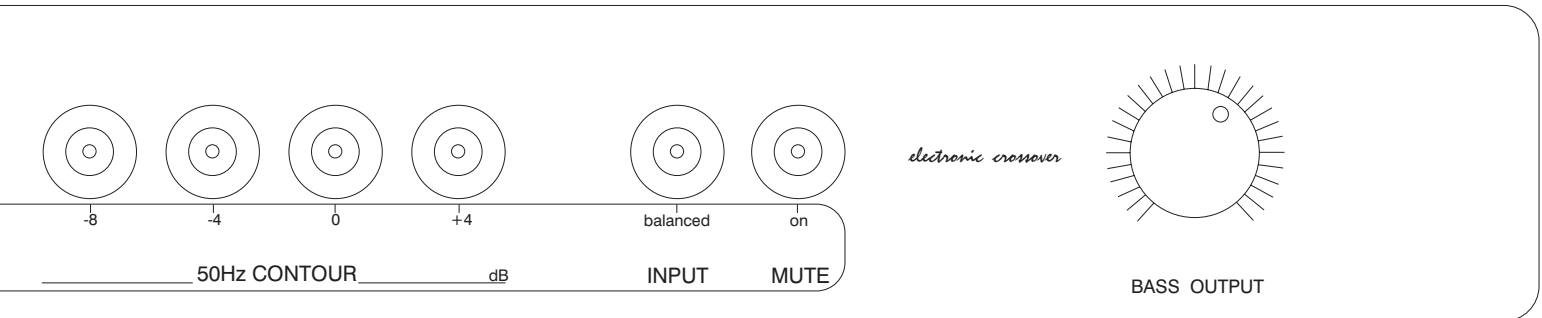

User's Manual

Electronic Crossover
for the
STATEMENT
evolution 2

Electrostatic Hybrid
High Resolution
Loudspeaker System



c / l / s / e / l / e / c / t / r / o / s / t / a / t / i / c



Introduction

Thank You for choosing Martin-Logan. We are deeply committed to building only products of uncompromised quality and technology and are dedicated to achieving perfection in everything we do. By choosing Martin-Logan, you have demonstrated your own dedication to the finer things in life. You will not be disappointed with your choice.

The Martin-Logan EXOS CROSSOVER is a precision electronic instrument that represents the culmination of an intensive, dedicated group research program directed toward establishing a world class reference monitor. The EXOS CROSSOVER is an application specific crossover filter network containing both high and low pass active tone shaping that delivers the most linear and extended frequency response from the STATEMENT evolution 2 Speaker System.

We know you are anxious to listen to your new CROSSOVER - So, to speed you along, we have provided the EXOS CROSSOVER Users Manual. Please read and follow these instructions as you initially connect your CROSSOVER into your system. These instructions are important and will prevent you from experiencing any delay, frustration, or system damage which might occur in a trial and error procedure.

Happy Listening!

Front Panel Controls

25 & 50 Hz Controls

These controls allow you to tailor the music according to your room resonances. These controls do not change the cross-over frequency or the overall output of the woofer, they are designed to enhance specific frequency points to which your room is contributing or subtracting information. Most rooms will have what is known as a suck-out around 25 or 50 Hz, or may have a room resonance at those

frequencies. The frequency contour control allows you to select a specific area in which your room is offending the performance of your system and allows you to control that area.

The 25 Hz control provides a 12dB range of adjustment from -4dB to +8dB in increments of 4.

The 50Hz control also provides a 12dB range, but from -8dB to +4dB.

Boost/Cut of EXOS at 25 Hz and 50 Hz

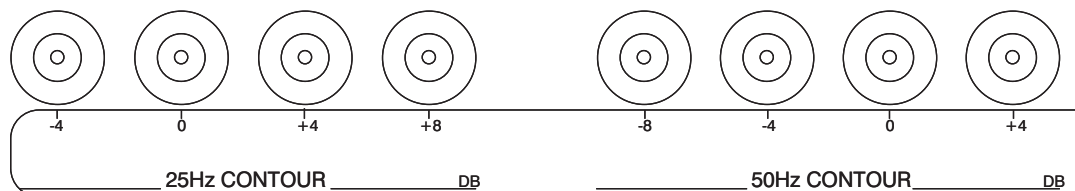
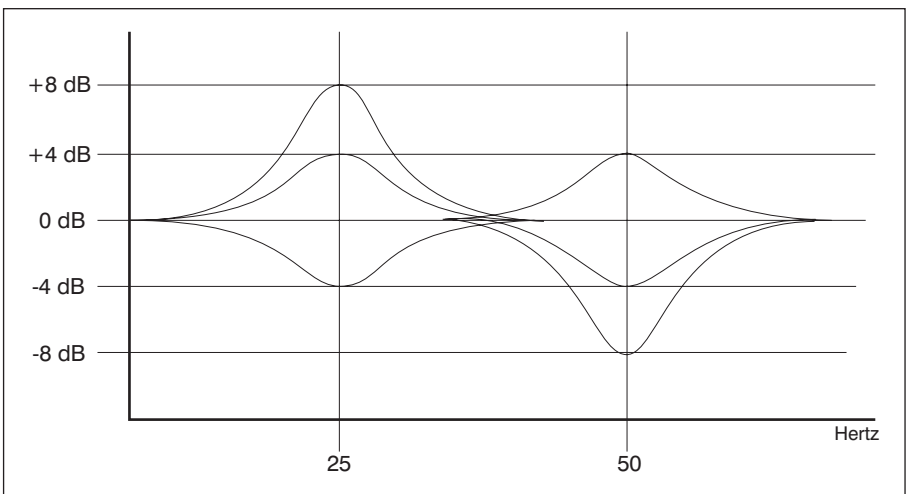

Input

When lit, indicates that balanced inputs are in use by the EXOS crossover. This button should be pressed to light the indicator LED if you are using balanced XLR connectors. Otherwise, press the button to toggle the LED off if RCA connectors are used.

Warning. All outputs are always on. Do not have both the RCA and balanced XLR connectors hooked-up simultaneously and attempt to use this button as an A/B switch. You will have degraded performance and possibly damage your equipment. Only one type of connector should be used throughout your system.

Push-Buttons

The EXOS uses precision push-buttons with LED indicators. A lit LED indicates that the button's function or option is on. The MUTE and BALANCED buttons toggle the options on and off. The CONTOUR buttons select the level of bass at the frequency option.

Battery Backup

An internal battery provides power to store your crossover settings in case of AC power interruption.

Mute

When lit, indicates that the outputs of the EXOS are disconnected so that no signal reaches the power amplifiers.

Bass output

This knob controls the overall level of bass relative to the rest of the music. Use it to adjust the amount of bass according to your taste or for matching the output level of your bass amplifier to that of your treble amplifier. Rotate to the left for less bass, to the right for more. Use this to fine tune the bass after properly setting the 25Hz and 50Hz contour controls.

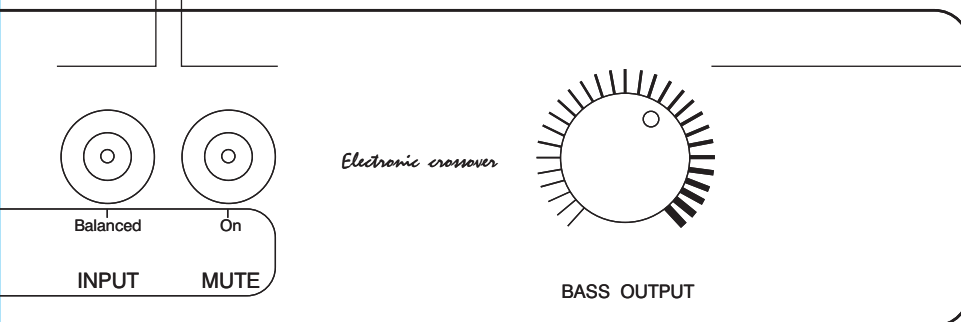

Output Connections (option one - most common)

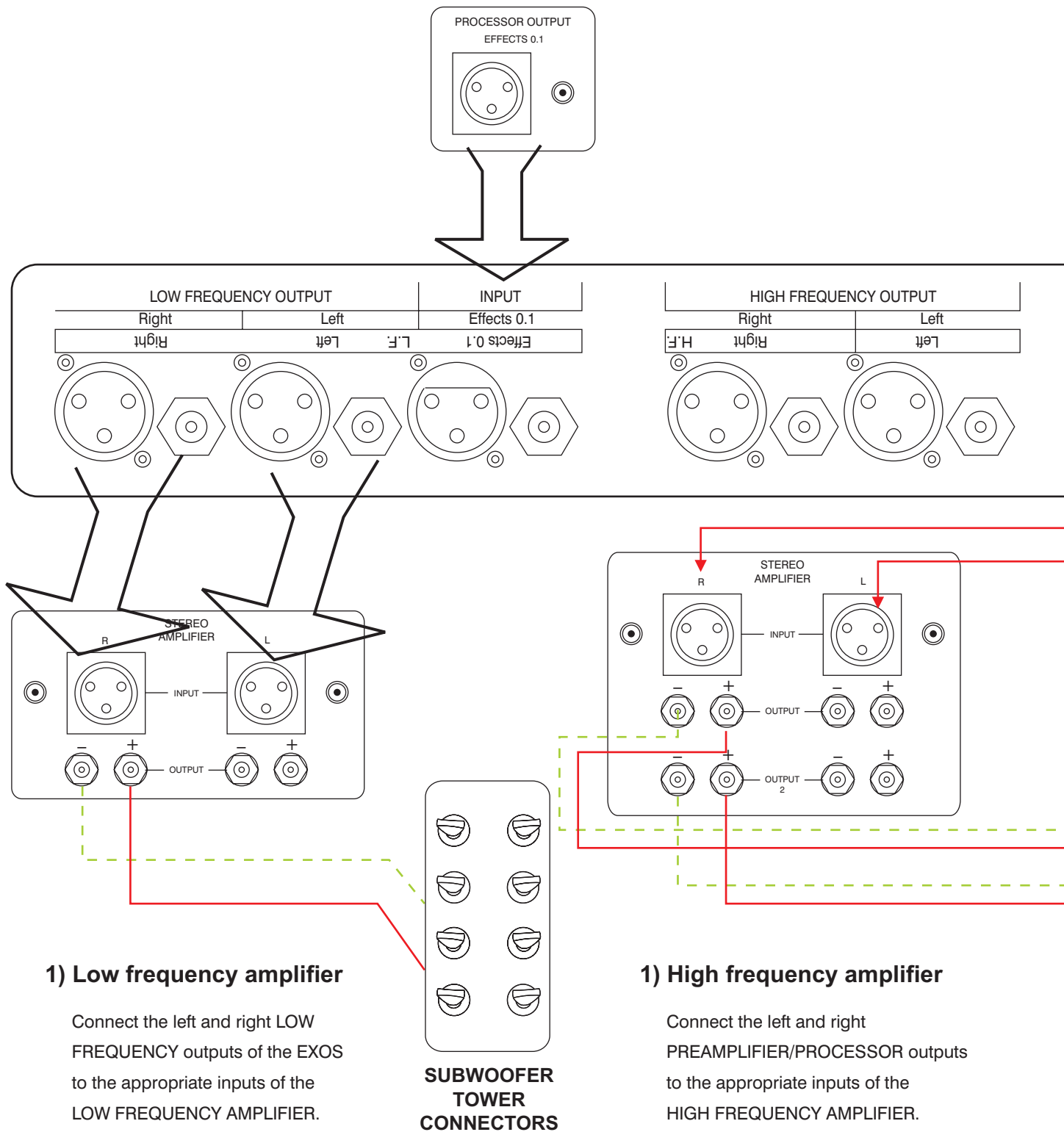

Input Connections (option one)

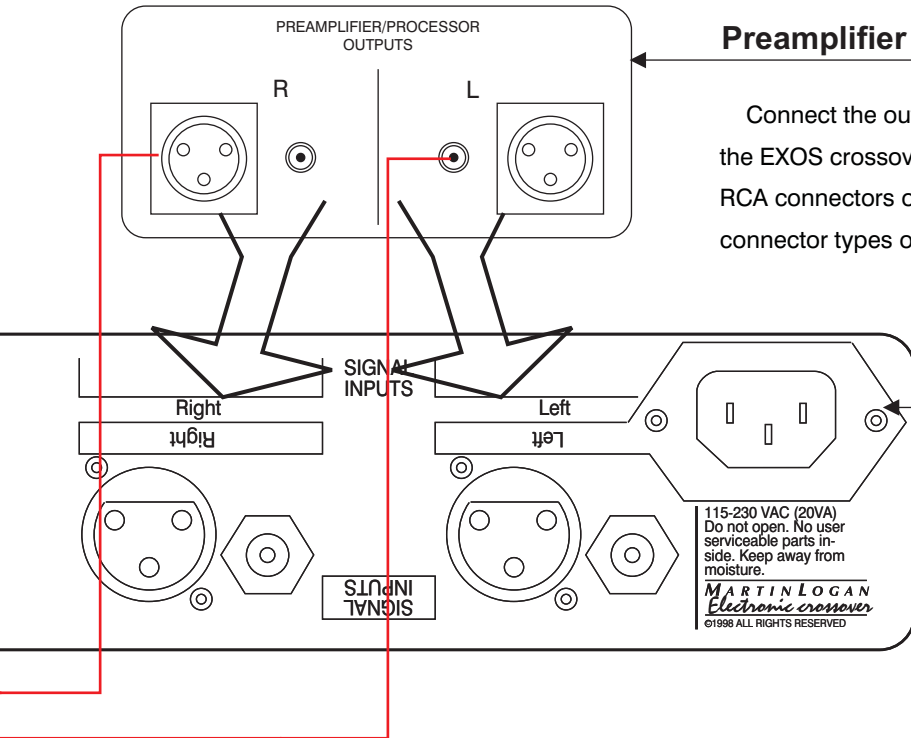

Preamplifier connections

Connect the outputs of your preamplifier to the respective inputs of the EXOS crossover. You may use either single-ended cables with RCA connectors or balanced cables via XLR connectors. Do not mix connector types or use both at once, use only one type at a time.

Power connection

After all signal connections have been made and you have verified that the power amps are off, install the AC cord into the EXOS first and then plug the other end into the outlet. The power cord should not be installed, removed or left detached while the other end is plugged into an AC outlet.

3) Statement evolution 2 interface

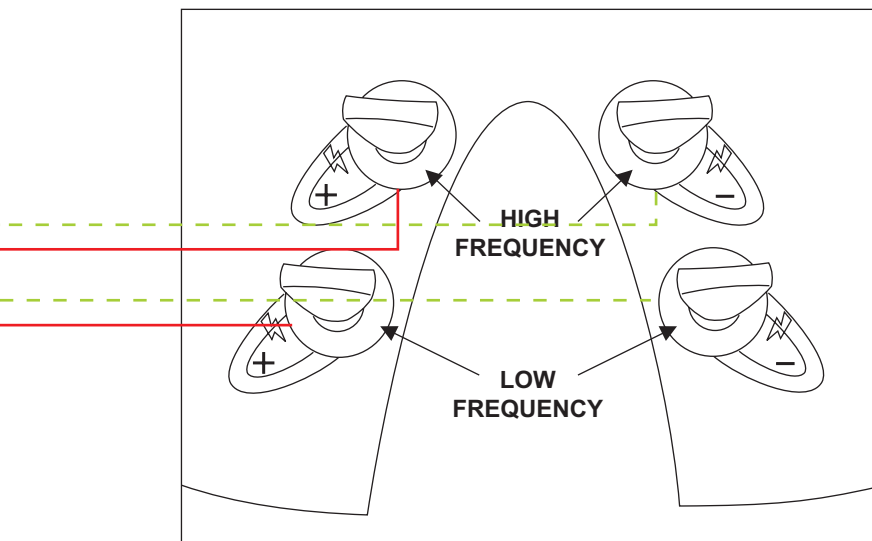

Next, connect the speaker leads from the high-pass amplifier to the HI SIGNAL INPUTS on the top of the base (scoop deck) on the back of the SPEAKERS. Then connect the second output of the high-pass amplifier signal leads to the MID SIGNAL INPUTS on the scoop deck. Use spade connectors for optimum contact and ease of installation. Make certain that all of your connections are clean, tight and positive. Be consistent when connecting the speaker cables to the SIGNAL INPUT terminals. Take care to assign the same polarity cable lead to the (+) terminal on both the left and right channel speakers.

Output Connections (option two)

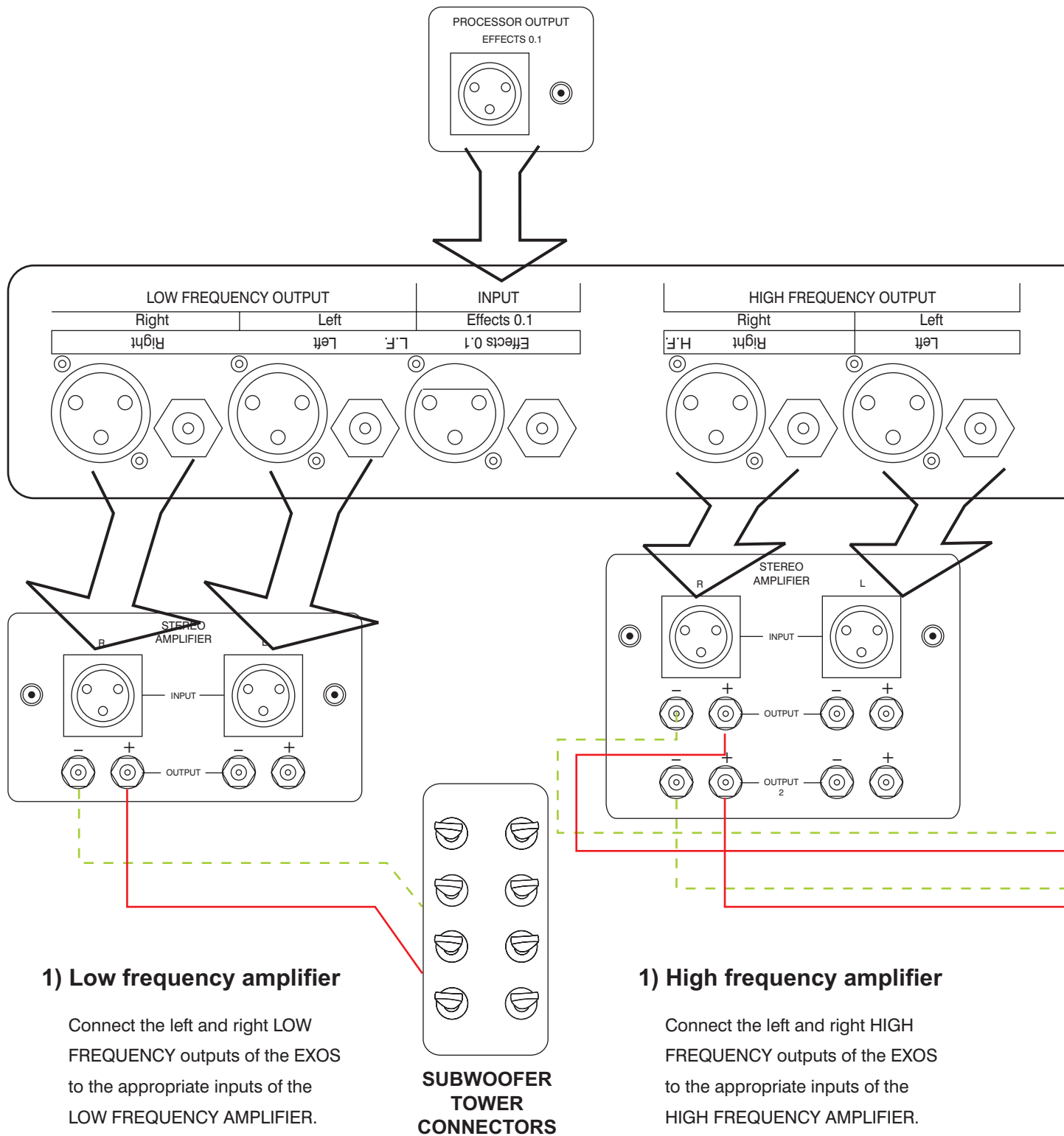

Input Connections (option two)

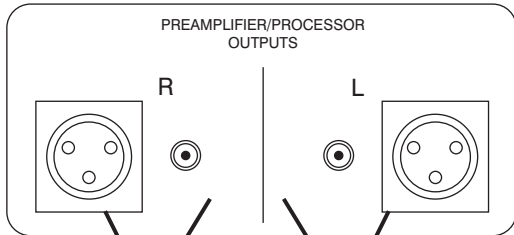

Preamplifier connections

Connect the outputs of your preamplifier to the respective inputs of the EXOS crossover. You may use either single-ended cables with RCA connectors or balanced cables via XLR connectors. Do not mix connector types or use both at once, use only one type at a time.

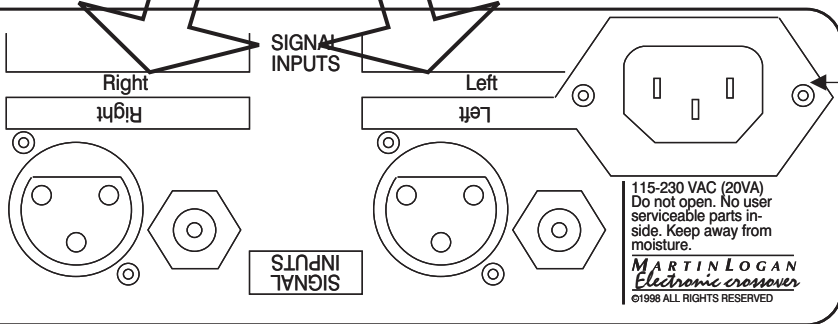

Power connection

After all signal connections have been made and you have verified that the power amps are off, install the AC cord into the EXOS first and then plug the other end into the outlet. The power cord should not be installed, removed or left detached while the other end is plugged into an AC outlet.

3) Statement evolution 2 interface

Next, connect the speaker leads from the high-pass amplifier to the HI SIGNAL INPUTS on the top of the base (scoop deck) on the back of the SPEAKERS. Then connect the second output of the high-pass amplifier signal leads to the MID SIGNAL INPUTS on the scoop deck. Use spade connectors for optimum contact and ease of installation. Make certain that all of your connections are clean, tight and positive. Be consistent when connecting the speaker cables to the SIGNAL INPUT terminals. Take care to assign the same polarity cable lead to the (+) terminal on both the left and right channel speakers.

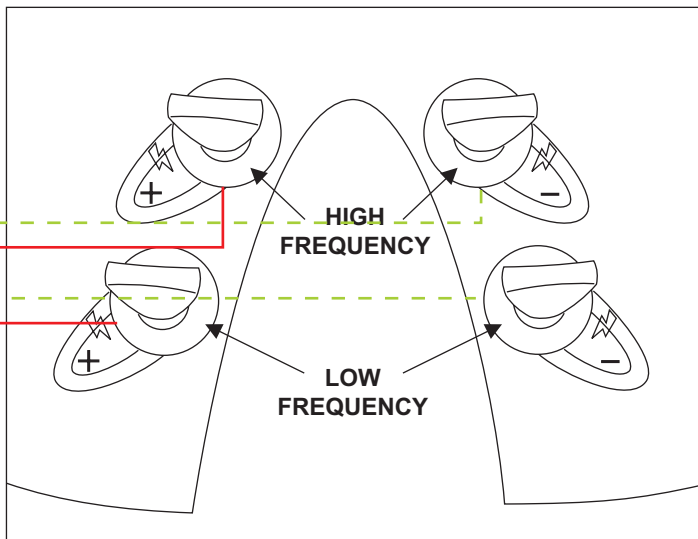

Operation

Use of the STATEMENT EXOS crossover will result in substantial improvements in all aspects of your system's performance. Bass will be more extended with more impact and control. Special bass contour controls allow you to tailor the bass response to suit your particular room environment or listening tastes. The crossover region between the woofer and electrostatic panel is optimized, thus making the system blend much more homogeneous. Highs are much more extended, detailed and effortless. The system becomes much more dynamic with less strain. When bi-amplifying with the EXOS crossover, the right and left full-bandwidth signals are divided into separate high and low frequency signals after the preamplifier by means of an active electronic crossover. These signals are then fed to dedicated high and low frequency amplifiers. With the frequency division of the signal prior to amplification, each amplifier has only to contend with frequencies of a narrow bandwidth, thus it cannot combine high and low frequency signals and produce sum and difference by-products (intermodulation distortion or IM). For example, to reproduce deep bass such as an organ tone or kick drum, very high power (current) is needed. Since the low frequencies have their own dedicated amplifier, this demand for low frequency power will not affect the ability of the high frequency amplifier to perform its function normally, whereas if all frequencies were reproduced by the same amplifier, its power supply might temporarily be depleted by the deep bass passage, causing dynamic compression or clipping of the high frequency material. Another added benefit of bandwidth limiting an amplifier, particularly the high frequency amplifier, is the slight increase in dynamic power output that occurs. The amplifier does not have to work as hard due to the reduction in the bandwidth amplification requirements. Therefore the amplifier can apply more power into the smaller frequency region.

The EXOS and Your Room

Today we are finding all elements in the audio chain can and will affect your system's performance. Of these elements, your room is the worst offender. Once the precisely tailored musical signal is launched from your speaker system, your room then has its way with that musical signal, particularly with the larger wavelengths of the bass region. Your room will enhance and cancel certain frequencies, making a perfect speaker look less than perfect in the best of instances and like a jumbled mess in the worst of instances. The Bass Contour controls of the EXOS crossover can be used much like an accurate bass/room equalizer, designed to neutralize the specific problem areas of your room, thus helping you optimize the performance of the STATEMENT evolution 2. These are a very accurate and precise pair of controls that allow you to adjust your speakers output in the bass region, the most problematic area of music reproduction.

Specifications

THD

less than 0.01%

Input Impedance

1.00 Mohms

Output Impedance

33 ohms

Maximum Output Voltage

20 volts peak to peak

Dimensions

19" x 12.5" x 2.75"

Weight

boxed: 18 lbs unboxed: 14 lbs

Rear Panel Descriptions

Inputs: left, right and effects

Outputs: left and right high frequency

left and right low frequency

Balanced via 3 pin XLR connector

Single ended via RCA connector

XLR Pin Configuration

pin 1 Shield (ground)

pin 2 Non-inverting or 0 degrees

pin 3 Inverting or 180 degrees

Packaging

Please save all packaging and store in a dry place away from potential fire hazard. Your EXOS crossover is a precision electronic instrument and should be packaged properly in its original carton any time shipment is necessary. We hope that you will never have occasion to return your unit to our factory for service, but in the event that servicing should prove necessary, or other occasion requiring shipment occurs, the original packaging will protect your unit from unnecessary damage or delay.

Warranty

There are no user serviceable parts inside the EXOS. The EXOS has a limited warranty of three years on parts and labor. The warranty period begins on the date of purchase and is activated with the return of the enclosed Certificate of Registration and a copy of the Sales receipt. Please return the Certificate of Registration immediately after successful installation and operation are completed.

The warranty for Martin-Logan products is valid only in the country to which they were originally shipped. If you think there may be a problem with your unit, immediately contact your dealer, distributor or the Martin-Logan factory.

Contact your Martin-Logan dealer to discuss any problem and, if necessary, to obtain a Return Authorization number before returning any unit to Martin-Logan for repair. Freight to the factory or distributor is your responsibility. Return freight to you will be paid by the factory or distributor. Any unauthorized updates or modifications performed to the unit will void the warranty.

c l s e l e c t r o s t a t i c

MARTIN LOGAN

2101 Delaware Street, Lawrence, Kansas 66046, USA tel 785.749.0133 fax 785.749.5320 www.martinlogan.com

©2000 MartinLogan, All rights reserved